



/// SCANIA

		Page
73716300	Scania L111 112 113 Hw	349
73714745	Scania L111 112 Hw	353
73796315	Scania L112 113 Hw	
73710109	Scania Dsc 124 360 Hp	357
73710429	Scania Dsc 124 360 400 Hp	
73710109	Scania Dsc 124 360 420 Hp	
73730101	Scania Dsc 124 360 400	360



N°SET	DESCRIPTION
73716300	FULL GASKET SET SCANIA L111 / 112 W/OIL SEAL AND SEAL RING 89
63714745	FULL GASKET SET SCANIA L111 / 112 W/O OIL SEAL 89
73714745	FULL GASKET SET SCANIA L111 / 112 W/OIL SEAL 89
73796310	FULL GASKET SET SCANIA L112 / 113HW W/OIL SEAL AND SEAL RING 09/89
63796315	FULL GASKET SET SCANIA L112 / 113HW W/O OIL SEAL 09/89
73796315	FULL GASKET SET SCANIA L112 / 113HW W/OIL SEAL 09/89
63734745	HEAD GASKET SET SCANIA L111 / 112 W/O OIL SEAL 89
63736345	HEAD GASKET SET SCANIA L112 / 113H W W/O OIL SEAL 09/89

ABR N°	ORIGINAL N°	DESCRIPTION	1	2	3	4	5	6	7	8
53702867	35161	WATER PIPE GASKET	1	1	1	1	1	1	1	1
53702967	35309	BREATHER GASKET	1	1	1	1	1	1	1	1
53704850	131103	VALVE COVER GASKET	2	2	2	2	2	2	2	2
53704990	131131	CYLINDER HEAD HOSE GASKET	1	1	1	1	1	1	1	1
53705090	131133	THERMOSTAT GASKET	2	2	2	2	2	2	2	2
53705167	131166	SLIDE COVER GASKET	2	2	2	2	2	2	2	2
53705267	287554	REAR COVER GASKET	1	1	1	1	1	1	1	1
53705667	139274	COVER HOUSING GASKET	1	1	1	1	1	1	1	1
53705790	277632	INTAKE MANIFOLD GASKET	2	2	2	2	2	2	2	2
53706567	287555	REAR COVER SEAL	1	1	1	1	1	1	1	1
53706667	139044	THERMOSTAT GASKET								
53706867	277637	DAMPER GASKET	1	1	1	1	1	1	1	1
53706985	139123	ROCKERSHAFT COVER GASKET	6	6	6	6	6	6	6	6
53707090	139144	TIMING COVER GASKET								
53707165	139146	FRONT CRANKSHAFT OIL SEAL	1	1	1	1	1	1	1	1
53707265	139149	REAR CRANKSHAFT OIL SEAL	1	1	1	1	1	1	1	1
53707567	1675602	TIMING COVER GASKET	1	1	1	1	1	1	1	1
53708667	162142	DISTRIBUTION GASKET	1	1	1	1	1	1	1	1
53709490	2155242	OIL PAN GASKET	1	1	1	1	1	1	1	1
53709770	238775	OIL PUMP COVER GASKET	1	1	1	1	1	1	1	1
53710030		FLYWHEEL SMALL GASKET	3	3	3	3	3	3	3	3
53710130		CONNECTING ROD GASKET	1	1	1	1	1	1	1	1
53710630		FLYWHEEL GASKET	1	1	1	1	1	1	1	1
53710967	131236	WATER PUMP GASKET	1	1	1	1	1	1	1	1
53714867	170765	OIL FILTER GASKET	1	1	1	1	1	1	1	1
53715067	232961	OIL FILTER GASKET	1	1	1	1	1	1	1	1
53715117	131294	EXHAUST MANIFOLD GASKET	2					2	2	2
53715217	131295	EXHAUST MANIFOLD GASKET	2					2	2	2
53715367	235610	OIL SEAL GASKET	1	1	1	1	1	1	1	1
53715467	238148	THERMOSTAT COVER GASKET						1	1	1
53715567	283403	OIL FILTER GASKET ÓLEO	1	1	1	1	1	1	1	1
53717467	238309	OIL FILTER GASKET	1	1	1	1	1	1	1	1
53717667	272793	SLIDE COVER GASKET CARTER	1	1	1					
53723616	1109288	EXHAUST MANIFOLD GASKET	2					2	2	2
53723716	378264	EXHAUST MANIFOLD GASKET	2					2	2	2
53725105	373472	CYLINDER HEAD GASKET	2	2	2	2	2	2	2	2
53725267	292759	INLET WATER PIPE GAS-	1	1	1	1	1	1	1	1
53725790	1675584	KETINTAKE MANIFOLD GASKET	2	2	2	2				
53725890	1675583	INTAKE MANIFOLD GASKET	4	4	4	4				
53725967	295050	THERMOSTAT GASKET	1	1	1					
53726067		OIL SEAL GASKET	2	2	2					
53726167	371238	COMPRESSOR GASKET	1	1	1	1	1	1	1	1
53726267	338332	INTAKE MANIFOLD GASKET	1	1	1	1				
53726367	277633	SLIDE COVER GASKET	1	1	1	1				
53726467	287334	THERMOSTAT GASKET	1	1	1					
53726567	287559	ENGINE BREATHER GASKET	1	1	1	1				
53726667		OIL SEAL GASKET	1	1	1					
53726767		OIL SEAL GASKET	1	1	1	1	1	1	1	1
53729245		LINER RING GASKET					12			18
53754440	1302828	LINER SHIM					6			
83727526		WASHER KIT SUP	1	1						
83727629		WASHER KIT	1	1	1	1	1	1	1	1
83727741		RUBBER KIT	1	1	1					
RE02069S		REAR OIL SEAL	1	1	1					
RE02235S		OIL SEAL DIANTEIRO	1	1	1					

APPLICATION

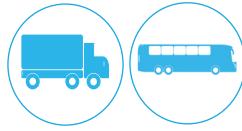

SCANIA DN11/DS11 6 CIL 11L(SERIE 2)
SCANIA TRUCK 112H 1982/86 ; 112HS 1987/89 ; 112HW 1989/91
SCANIA BUS S112/K112 1983/91
SCANIA DS11/DSC11 6 CIL 11L(SERIE 3)
SCANIA TRUCK R113E/R113H 1991/98 ; T113E/T113H 1991/98
SCANIA BUS S113 1991/93 ; L113 1993/98 ; K113 1994/98

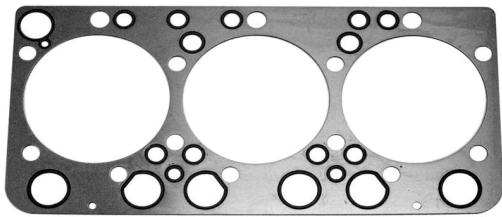

53725105

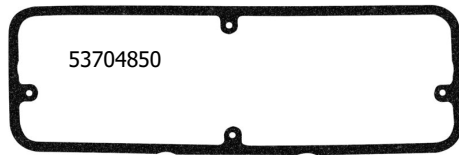

53704850



53715117

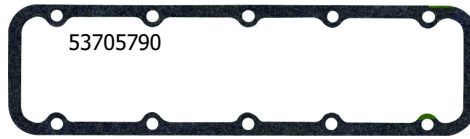

53705790



53715217

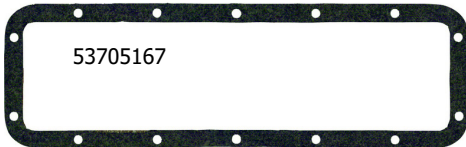

53705167

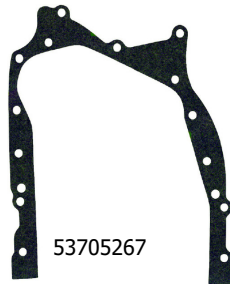

53705267



53706985

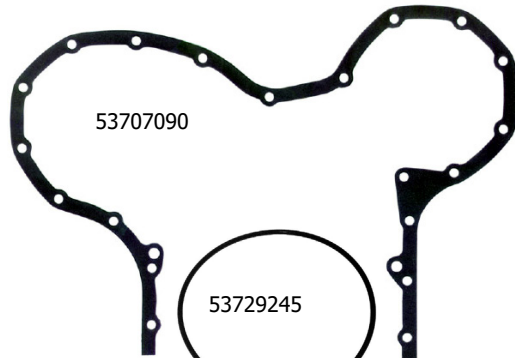

53707090

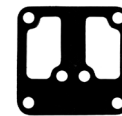

53704990



53723716



53729245

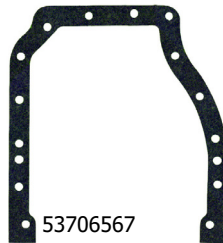

53706567



53725267



53723616

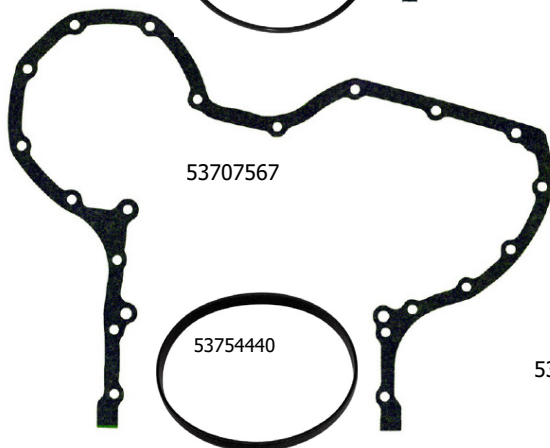

53707567

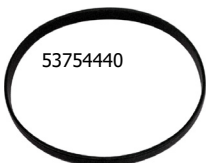

53754440



53705667



53706867



53725890



53726667



53726467



53715367

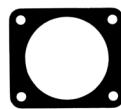

53726567



53726267/



53725790



53726067



53715467

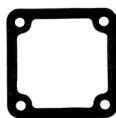

53717667



53714867



53715067

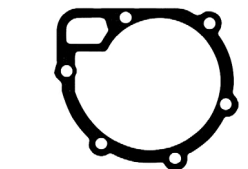

53710967



53726167

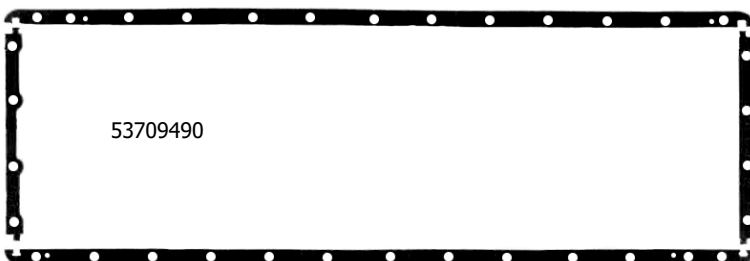

53709490



53725967



53706667



53705090



53702867

SCANIA

SCANIA L111 / 112 / 113HW



53708667



53702967



53726367



53717467

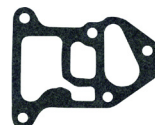

53715567



53710130



53710030



53710630

83727629		
Nº ABR	DESCRIPTION	Qty
50011323	Arruela CU 8,3 x 13,8 x 1,0 mm	01
50083330	Arruela AC 9,5 x 20,0 x 2,0 mm	06
50021229	Arruela AL 14,0 x 20,0 x 1,5 mm	10
50018529	Arruela AL 12,0 x 16,0 x 1,5 mm	08
50012223	Arruela CU 8,0 x 12,0 x 1,0 mm	14
50071228	Arruela AL 26,4 x 33,7 x 1,0 mm	01
50025829	Arruela AL 18,0 x 24,0 x 1,0 mm	01
50015528	Arruela AL 10,0 x 16,0 x 1,0 mm	12
	Arruela CU 10,2 x 21,3 x 1,8 mm	06
50015429	Arruela AL 10,0 x 14,0 x 1,5 mm	04
50026728	Arruela AL 20,0 x 26,0 x 1,0 mm	02

83727741		
Nº ABR	DESCRIPTION	Qty
50028141	Vedador 106,7 x 3,5 mm	01
50027941	Vedador 106,5 x 2,1 mm	01
50005741	Vedador 20,0 x 4,0 mm	03
50010941	Vedador 26,0 x 3,2 mm	02
50009141	Vedador 59,0 x 3,4 mm	01
50028841	Vedador 126,0 x 5,0 mm	01
50029141	Vedador 135,0 x 2,8 mm	02
50030741	Vedador 43,5,0 x 3,4 mm	02
50031441	Vedador 53,0 x 3,3 mm	02
50034241	Vedador 10,2 x 3,2 mm	01
50035841	Vedador 41,5 x 56,3 x 3,5 mm	01
50036941	Vedador 13,0 x 2,5 mm	02
50039641	Vedador 16,0 x 2,4 mm	01
50040541	Vedador 19,0 x 3,2 mm	03
50054541	Vedador 34,5 x 46,0 x 2,5 mm	01
50055141	Vedador 18,0 x 29,0 x 4,3 mm	04
50026841	Vedador 74,2 x 3,5 mm	02
53702441	Vedador THERMOSTAT	01
53751041	Vedador Tampa Válvula	04

83727526		
Nº ABR	DESCRIPTION	Qty
50014123	Arruela CU 9,5 x 20,0 x 1,0 mm	06
50002129	Arruela AL 14,0 x 20,0 x 1,5 mm	04
50018529	Arruela AL 12,0 x 16,0 x 1,5 mm	08
50012223	Arruela CU 8,0 x 12,0 x 1,0 mm	14



53707165



53707265



RE02235S



RE02069S

N°SET	DESCRIPTION		
63710435	FULL GASKET SET SCANIA 112 / 113HW UNIFICADO S/ANEL CAMISA W/OIL SEAL		1
73710435	FULL GASKET SET SCANIA 112 / 113HW UNIFICADO C/ANEL CAMISA W/OIL SEAL		2
63730435	HEAD GASKET SET SCANIA L111 / 112 / 113HW UNIFICADO W/O OIL SEAL		3
ABR N°	ORIGINAL N°	DESCRIPTION	
53702867	35161	WATER PIPE GASKET	1 1 1
53702967	35309	PUSH ROD COVER GASKET	1 1 1
53704850	131103	VALVE COVER GASKET	2 2 2
53704990	131131	CYLINDER HEAD GASKET	1 1 1
53705090	131133	THERMOSTAT GASKET	2 2 2
53705167	131166	SLIDE COVER GASKET	2 2 2
53705267	287554	REAR COVER GASKET	1 1 1
53705667	139274	COVER HOUSING GASKET	1 1 1
53705790	277632	INTAKE MANIFOLD GASKET	2 2 2
53706567	287555	FLYWHEEL COVER GASKET	1 1 1
53706667	139044	TERMOSTAT GASKET	1 1 1
53706867	277637	OIL FILTER GASKET	1 1 1
53706985	139123	ROCKER SUPPORT GASKET	6 6 6
53707090	139144	TIMING COVER GASKET	1 1 1
53707165	139146	FRONT CRANKSHAFT OIL SEAL	1 1 1
53707265	139149	REAR CRANKSHAFT OIL SEAL	1 1 1
53707567	1675602	TIMING COVER GASKET	1 1 1
53708667	162142	DISTRIBUTION GASKET	1 1 1
53709490	2155242	OIL PAN GASKET	1 1 1
53709770	238775	OIL COVER PUMP GASKET	1 1 1
53710030		FLYWHEEL SMALL GASKET	3 3 3
53710130		CONNECTING ROD GASKET	1 1 1
53710630		FLYWHEEL GASKET	1 1 1
53710967	131236	WATER PUMP GASKET	1 1 1
53714867	170765	OIL FILTER GASKET	1 1 1
53715067	232961	OIL FILTER GASKET	1 1 1
53715117	131294	EXHAUST MANIFOLD GASKET	2 2 2
53715217	131295	EXHAUST MANIFOLD GASKET	2 2 2
53715367	235610	OIL SEAL GASKET	1 1 1
53715467	238148	THERMOSTAT COVER GASKET	1 1 1
53715567	283403	OIL FILTER GASKET ÓLEO	1 1 1
53717467	238309	OIL FILTER GASKET	1 1 1
53717667	272793	SLIDE COVER GASKET CARTER	1 1 1
53723616	1109288	EXHAUST MANIFOLD GASKET	2 2 2
53723716	378264	EXHAUST MANIFOLD GASKET	2 2 2
53725105	373472	CYLINDER HEAD GASKET	2 2 2
53725267	292759	INLET WATER PIPE GASKET	1 1 1
53725790	1675584	INTAKE MANIFOLD GASKET	2 2 2
53725890	1675583	INTAKE MANIFOLD GASKET	4 4 4
53725967	295050	THERMOSTAT GASKET	1 1 1
53726067		OIL SEAL GASKET	1 1 1
53726167	371238	COMPRESSOR GASKET	1 1 1
53726267	338332	INTAKE MANIFOLD GASKET	1 1 1
53726367	277633	SLIDE COVER GASKET	1 1 1
53726467	287334	THERMOSTAT GASKET	1 1 1
53726567	287559	ENGINE BREATHER GASKET	1 1 1
53726667		OIL SEAL GASKET	1 1 1
53726767		OIL SEAL GASKET	1 1 1
53729245		LINER RING	18 18 18
53754440	1302828	LINER SHIM	6 6 6
82160177		TURBOCHARGING GASKET	1 1 1
83721077		TURBOCHARGING GASKET	1 1 1
83727526		TOP WASHER KIT	1 1 1
83727629		WASHER KIT	1 1 1
83727741		RUBBER KIT	1 1 1
RE02069S		REAR OIL SEAL	1 1 1
RE02235S		FRONT OIL SEAL	1 1 1

APPLICATION

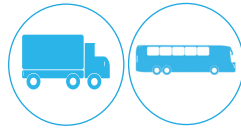

SCANIA DN11/DS11 6 CIL 11L(SERIE 2)
SCANIA TRUCK 112H 1982/86 ; 112HS 1987/89 ; 112HW 1989/91
SCANIA BUS S112/K112 1983/91
SCANIA DS11/DSC11 6 CIL 11L(SERIE 3)
SCANIA TRUCK R113E/R113H 1991/98 ; T113E/T113H 1991/98
SCANIA BUS S113 1991/93 ; L113 1993/98 ; K113 1994/98

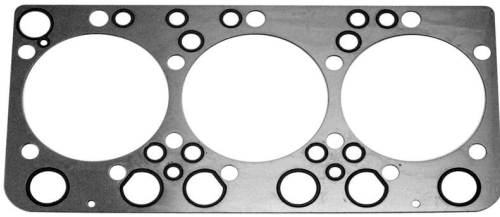

53725105

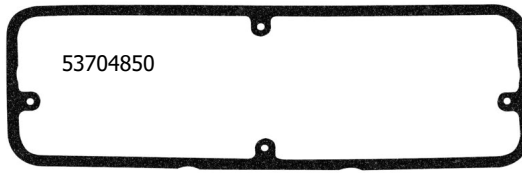

53704850



53704990



53705167

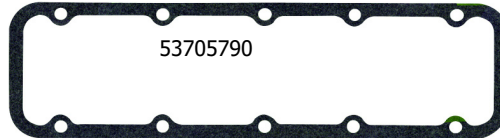

53705790



53706985

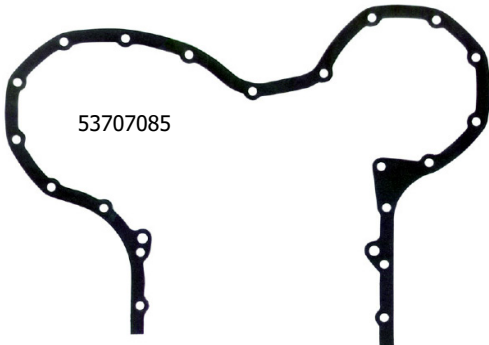

53707085

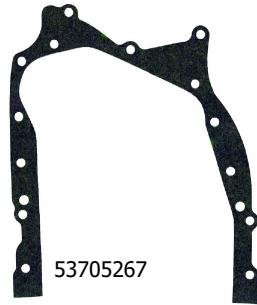

53705267



53723716



53723616

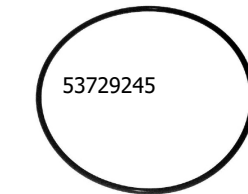

53729245



53725890

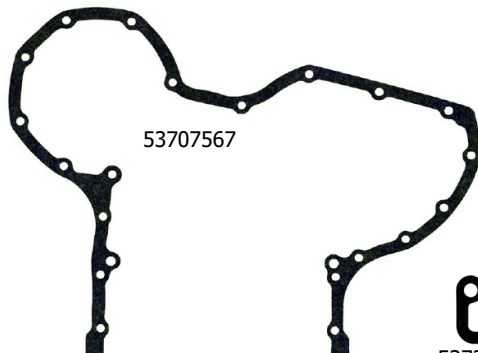

53707567

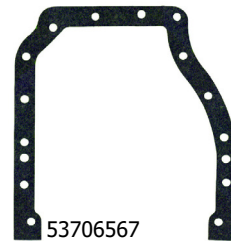

53706567



53754440
Nº ORIG1302828

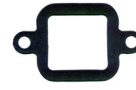

53725790



53726467



53715117

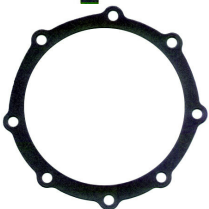

53708667



53726767



53726267



53706867



53715217



53715067

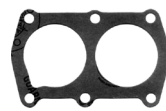

53726167



53709770

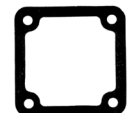

53717667



53715467



53706667



53715367



53714867



53726667



53705090

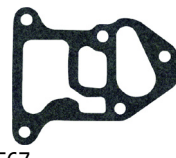

53715567



53709490

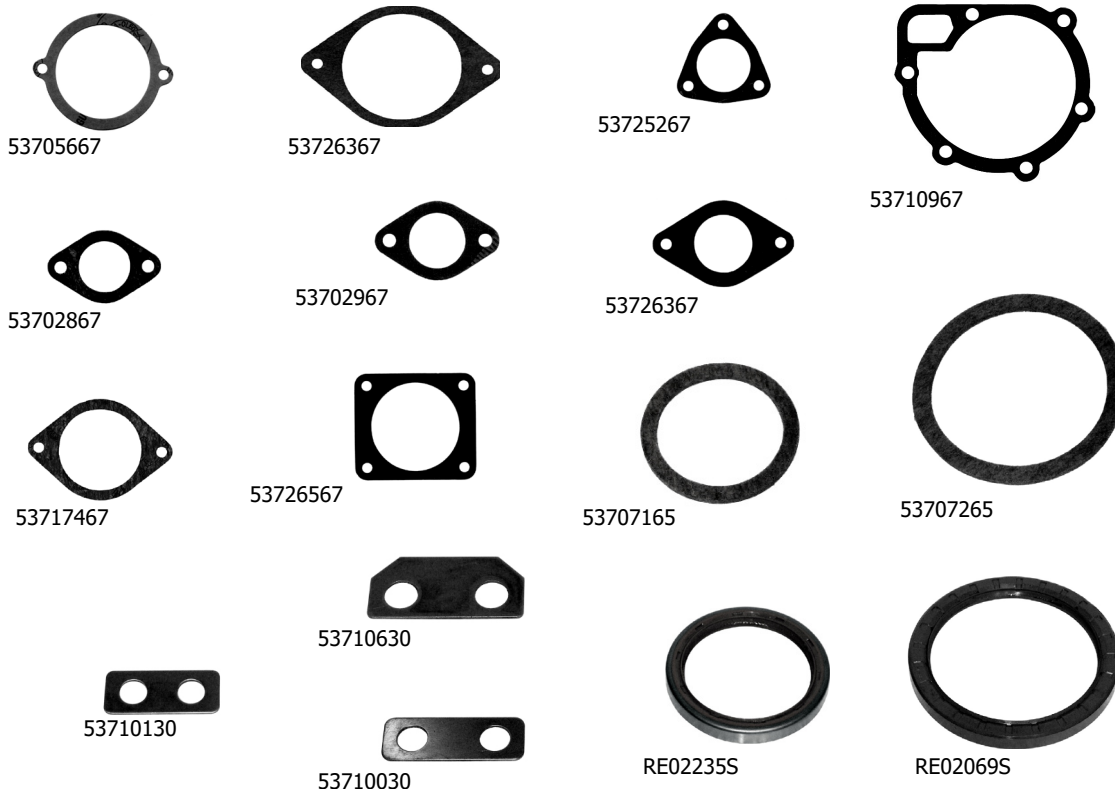

83721077 TURBOCHARGING

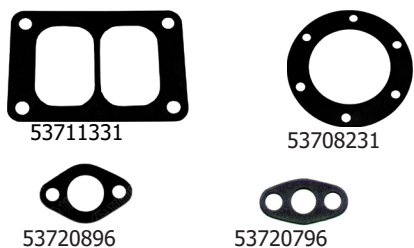

82160177 TURBOCHARGING

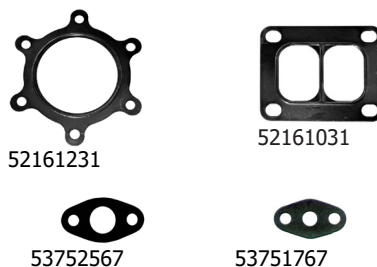

83727741		
Nº ABR	DESCRIPTION	Qty
50028141	Vedador 106,7 x 3,5 mm	01
50027941	Vedador 106,5 x 2,1 mm	01
50005741	Vedador 20,0 x 4,0 mm	03
50010941	Vedador 26,0 x 3,2 mm	02
50009141	Vedador 59,0 x 3,4 mm	01
50028841	Vedador 126,0 x 5,0 mm	01
50029141	Vedador 135,0 x 2,8 mm	02
50030741	Vedador 43,5,0 x 3,4 mm	02
50031441	Vedador 53,0 x 3,3 mm	02
50034241	Vedador 10,2 x 3,2 mm	01
50035841	Vedador 41,5 x 56,3 x 3,5 mm	01
50036941	Vedador 13,0 x 2,5 mm	02
50039641	Vedador 16,0 x 2,4 mm	01
50040541	Vedador 19,0 x 3,2 mm	03
50054541	Vedador 34,5 x 46,0 x 2,5 mm	01
50055141	Vedador 18,0 x 29,0 x 4,3 mm	04
50026841	Vedador 74,2 x 3,5 mm	02
53702441	Vedador THERMOSTAT	01
53751041	Vedador Tampa Válvula	04

83727629		
Nº ABR	DESCRIPTION	Qty
50011323	Arruela CU 8,3 x 13,8 x 1,0 mm	01
50083330	Arruela AC 9,5 x 20,0 x 2,0 mm	06
50021229	Arruela AL 14,0 x 20,0 x 1,5 mm	10
50018529	Arruela AL 12,0 x 16,0 x 1,5 mm	08
50012223	Arruela CU 8,0 x 12,0 x 1,0 mm	14
50071228	Arruela AL 26,4 x 33,7 x 1,0 mm	01
50025829	Arruela AL 18,0 x 24,0 x 1,0 mm	01
50015528	Arruela AL 10,0 x 16,0 x 1,0 mm	12
	Arruela CU 10,2 x 21,3 x 1,8 mm	06
50015429	Arruela AL 10,0 x 14,0 x 1,5 mm	04
50026728	Arruela AL 20,0 x 26,0 x 1,0 mm	02

83727526		
Nº ABR	DESCRIPTION	Qty
50014123	Arruela CU 9,5 x 20,0 x 1,0 mm	06
50002129	Arruela AL 14,0 x 20,0 x 1,5 mm	04
50018529	Arruela AL 12,0 x 16,0 x 1,5 mm	08
50012223	Arruela CU 8,0 x 12,0 x 1,0 mm	14

N°SET	DESCRIPTION
63710129	FULL GASKET SET SCANIA DSC124 360 HP 98/02 C/ANEL CAMISA, W/O OIL SEAL
73710129	FULL GASKET SET SCANIA DSC124 360 HP 98/02 C/ANEL CAMISA, W/OIL SEAL
63710429	FULL GASKET SET SCANIA DSC124 360/400 HP ATÉ 2002 C/ANEL CAMISA, W/O OIL SEAL
73710429	FULL GASKET SET SCANIA DSC124 360/400 HP ATÉ 2002 C/ANEL CAMISA, W/OIL SEAL
63710109	FULL GASKET SET SCANIA DSC124 360/420 HP 2002/ C/ANEL CAMISA, W/O OIL SEAL
73710109	FULL GASKET SET SCANIA DSC124 360/420 HP 2002/ C/ANEL CAMISA, W/OIL SEAL

ABR N°	ORIGINAL N°	DESCRIPTION	1	2	3	4	5	6
50014049		FRONT CRANKSHAFT OIL SEAL	1	1	1			
50014149		REAR CRANKSHAFT OIL SEAL	1	1	1			
RE09282F		OIL SEAL HASTE VALVULAS	1	1	1			
53726805	1468555	CYLINDER HEAD GASKET	6	6				
53751167	1374342	INTAKE PIPE MANIFOLD GASKET	1	1	1	1	1	1
53751267	1374346	OIL PIPE COOLER GASKET	1	1	1	1	1	1
53751367	1374334	FRONT COVER GASKET			1	1	1	1
53751467	1374344	WATER PUMP GASKET	1	1	1	1	1	1
53751567	1374336	PIPE TUBE GASKET	1	1	1	1	1	1
53751667	1375992	OIL PIPE GASKET	1	1	1	1	1	1
53751867	1374517	WATER FILTER GASKET	1	1	1	1	1	1
53751967	1374340	INTAKE MANIFOLD GASKET		6	6	6	6	6
53752067	1374338	INTAKE MANIFOLD GASKET		6	6	6	6	6
53752147	1309051	EXHAUST MANIFOLD GASKET	6	6	6	6	6	6
53752267	1375387	STEERING BOX COVER GASKET	1	1	1	1	1	1
53752367	1374346	HYDRAULIC PUMP GASKET	1	1	1	1	1	1
53752467	1375383	SLIDE COVER GASKET	3	3	3	3	3	3
53752667	1374327	STEERING BOX COVER GASKET	1	1	1	1	1	1
53752767	1374330	OIL NOZZLE JOIN	1	1	1	1	1	1
53752867	1391726	ROD RADIATOR GASKET	1	1	1	1	1	1
53752967	1374326	SLIDE COVER GASKET	3	3	3	3	3	3
53753067	1460359	OIL PAN GASKET	1	1	1	1	1	1
53753167	1374333	THERMOSTAT GASKET	1	1	1	1	1	1
53753230	1374842	VED TMP CABEÇOTE						
53753347	1524474	INTAKE MANIFOLD GASKET	6	6				
53754540	1445514	SLIDE COVER GASKET	1	1				
53754640	1433886	OIL RADIATOR GASKET	1	1				
53754705	1377039	CYLINDER HEAD GASKET		6	6	6	6	6
53754867	1403129	FRONT COVER GASKET	1	1				
82160177		TURBOCHARGING GASKET	1	1	1	1	1	1
83728640		VALVE COVER GASKET						1
83728740		VALVE COVER GASKET	1	1	1	1		
83728940		RUBBER KIT	1	1	1	1	1	1
83729029		WASHER KIT	1	1	1	1	1	1
83728840		RUBBER KIT			1	1	1	1
83729340		RUBBER KIT	1	1				

APPLICATION

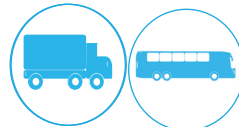

SCANIA DC11 6 CIL 24V 10.60L SERIE 4 MECANICO(EURO 3)
SCANIA TRUCK P114 1998/02 ; P124 1998/00 ; T124 1998/01 ; R114 1998/01 ; T114 1998/01
SCANIA DSC12 6 CIL 24V 11.70L SERIE 4 MECANICO(EURO 3)
SCANIA TRUCK R114 1999/99 ; R124 1998/01 ; T124 1998/01
SCANIA BUS K124 1999/01
SCANIA DSC12 6 CIL 24V 11.70L SERIE 4 ELETRONICO(EURO 3)
SCANIA TRUCK P114/R114/T114 2002/07 ; P124/R124/T124 2002/07
SCANIA BUS K124 2002/07



53754705

53753230

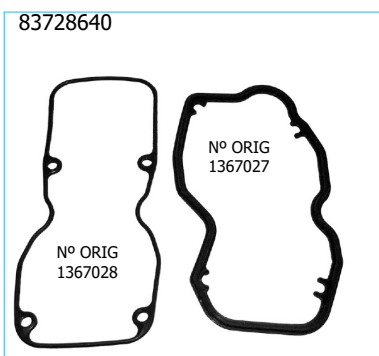

83728640

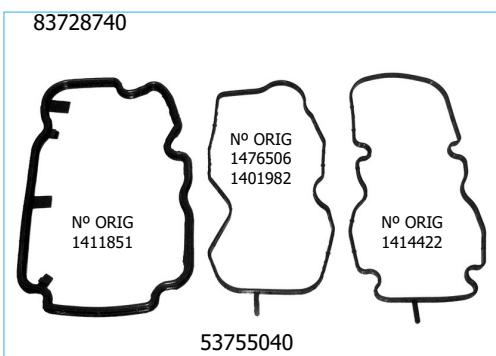

83728740

53755040



53752067



53751967



53752147

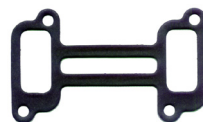

53753347

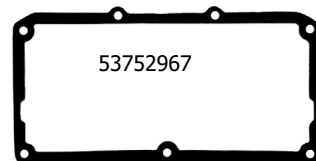

53752967

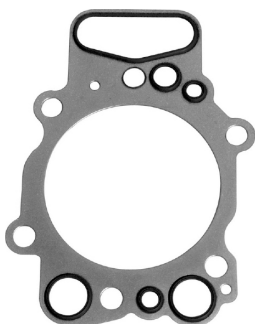

53726805



53753167

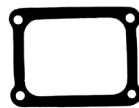

53751167

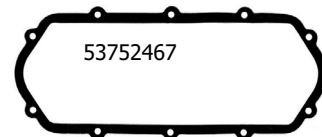

53752467

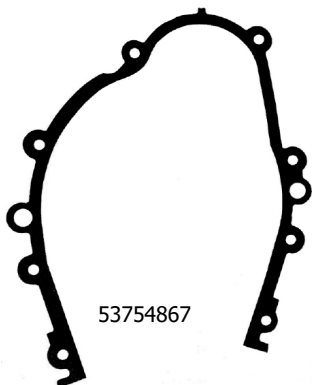

53754867



53751867

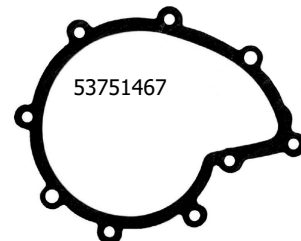

53751467

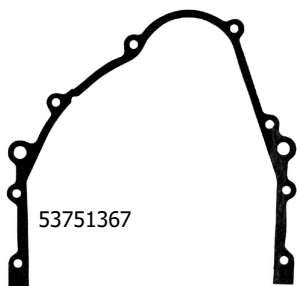

53751367

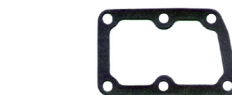

53751267



53751567



53752267

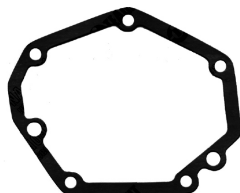

53752367



53752867



53752667



53751667



53752767



53753067

82160177



52161231



52161031
Nº ORIG 1393937



53751767



53752567

SCANIA DSC 124 (360 / 420)

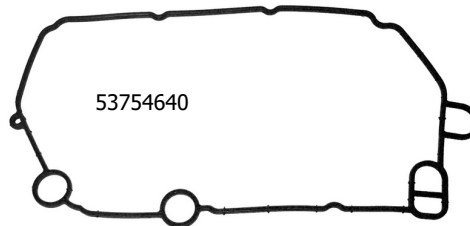
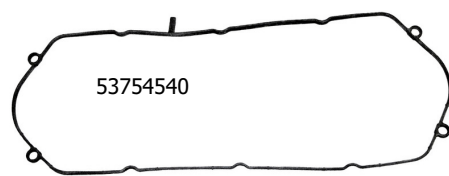
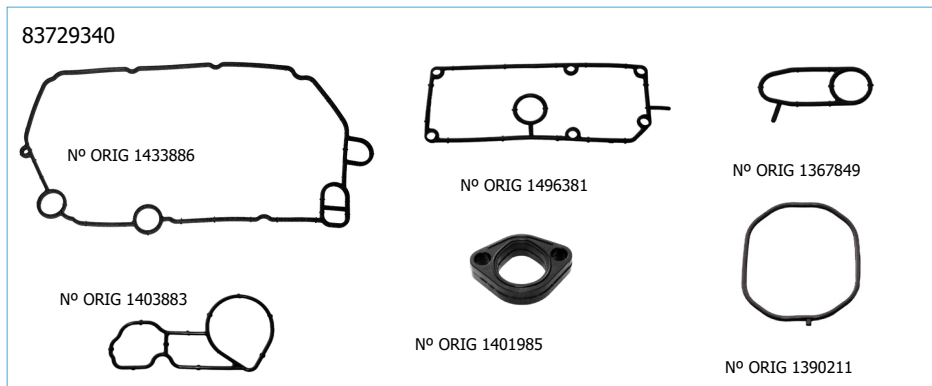
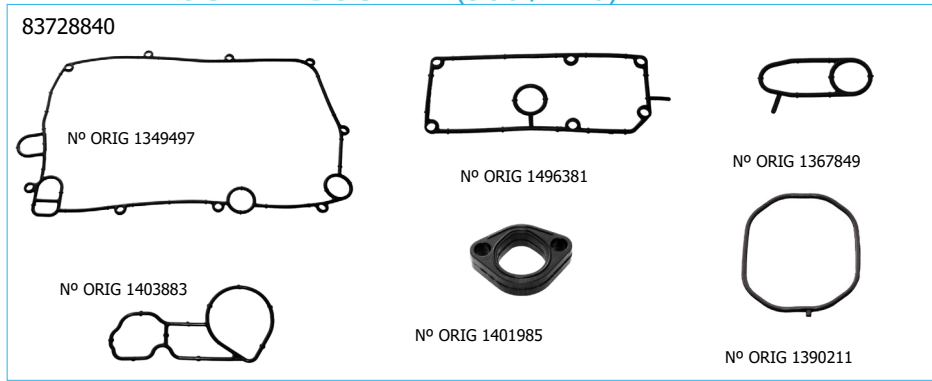

83728940		
Nº ABR	DESCRIPTION	Qty
50028141	Vedador 106,7 x 3,5 mm	01
50027941	Vedador 106,5 x 2,1 mm	01
50005741	Vedador 20,0 x 4,0 mm	03
50010941	Vedador 26,0 x 3,2 mm	02
50009141	Vedador 59,0 x 3,4 mm	01
50028841	Vedador 126,0 x 5,0 mm	01
50029141	Vedador 135,0 x 2,8 mm	02
50030741	Vedador 43,5 x 3,4 mm	02
50031441	Vedador 53,0 x 3,3 mm	02
50034241	Vedador 10,2 x 3,2 mm	01
50035841	Vedador 41,5 x 56,3 x 3,5 mm	01
50036941	Vedador 13,0 x 2,5 mm	02
50039641	Vedador 16,0 x 2,4 mm	01
50040541	Vedador 19,0 x 3,2 mm	03
50054541	Vedador 34,5 x 46,0 x 2,5 mm	01
50055141	Vedador 18,0 x 29,0 x 4,3 mm	04
50026841	Vedador 74,2 x 3,5 mm	02
53702441	Vedador THERMOSTAT	01
53751041	Vedador Tampa Válvulas	04

83729029		
Nº ABR	DESCRIPTION	Qty
56114120	Arruela CU 9,5 x 20,0 x 2,0 mm	06
50021228	Arruela AL 14,0 x 20,0 x 1,0 mm	20
50018529	Arruela AL 12,0 x 16,0 x 1,5 mm	08
50011228	Arruela AL 8,0 x 12,0 x 1,0 mm	18
50029827	Arruela AL 24,0 x 38,0 x 1,0 mm	01
50072429	Arruela AL 22,5 x 26,7 x 1,5 mm	02
50023329	Arruela AL 16,0 x 22,0 x 1,5 mm	06
50023629	Arruela AL 16,3 x 19,8 x 1,5 mm	08
50015428	Arruela AL 10,0 x 14,0 x 1,0 mm	04

N°SET	DESCRIPTION								
63730121	HEAD GASKET SET P/1 Cabeçote SCANIA DSC124 360 HP 98/02 W/O OIL SEAL								1
73730121	HEAD GASKET SET P/1 Cabeçote SCANIA DSC124 360 HP 98/02 W/OIL SEAL								2
63730421	HEAD GASKET SET P/1 Cabeçote SCANIA DSC124 360/400 HP ATÉ 2002 W/O OIL SEAL								3
73730421	HEAD GASKET SET P/1 Cabeçote SCANIA DSC124 360/400 HP ATÉ 2002 W/OIL SEAL								4
63730101	HEAD GASKET SET P/1 Cabeçote SCANIA DSC124 360/420 HP 2002/ W/O OIL								5
73730101	HEAD GASKET SET P/1 Cabeçote SCANIA DSC124 360/420 HP 2002/ W/OIL								6

ABR N°	ORIGINAL N°	DESCRIPTION							
50014120		INJECTION WASHER NOZZLE	1	1	1	1	1	1	1
RE09282F		INTAKE MANIFOLD SET	4		4			4	
53726805	1468555	CYLINDER HEAD GASKET	1	1					
53751967	1374340	INTAKE MANIFOLD GASKET				1	1	1	1
53752067	1374338	INTAKE MANIFOLD GASKET					1	1	1
53752147	1309051	EXHAUST MANIFOLD GASKET	1	1	1	1	1	1	1
53753230	1374842	CYLINDER HEAR GASKET	6	6	6	6	6	6	6
53753347	1524474	INTAKE MANIFOLD GASKET	1	1					
53754705	1377039	CYLINDER HEAD GASKET				1	1	1	1
53755240	1340615	INJECTION GASKET	4	4	4	4	4	4	4
53755340	1368061	VED COL COMBUSTIVEL	1	1	1	1	1	1	1
83728640		VALVE COVER GASKET SET						1	1
83728740		VALVE COVER GASKET SET	1	1	1	1			

APPLICATION





53754705

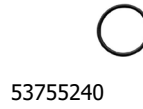
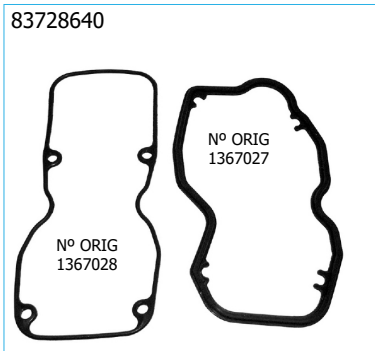

53755240



53752067



53751967



53752147



RE09282F



53755340



53753230



53753347

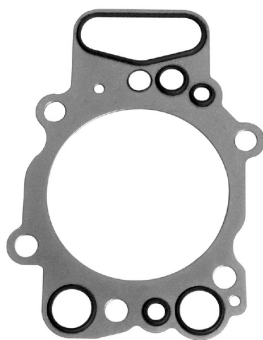
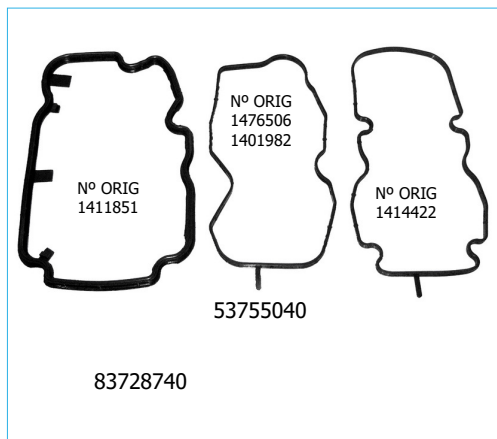

53726805



50014120